

RP 100 ()

GENERAL DATA



PROTECTION GUARD FOR LONG CASE AXIAL FANS

MANUFACTURING FRATURES

- Protection guard for motor or impeller side to avoid objects introduction. For SCAP and SCA model, RP can be applied only to impeller side.
- Made of welded metal wire.
- According to ROHS 2002/95/EC Directive.

UNDER REQUEST

- Stainless guard 304 or 316 with electro-polished finishing coat.

TECHNICAL DATA

approx. weight 8.20 Kg

DIMENSIONS

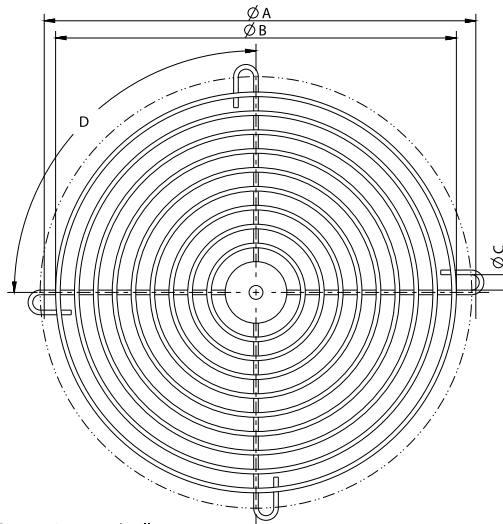

NOTA: Cota maxima entre barillas 10mm.

Dimensions (mm)

D	8x45°	Ø A	1070	Ø B	1028	Ø C	10
---	-------	-----	------	-----	------	-----	----